



seele

retail façades
a brand's crown jewel



The seele group of companies, with headquarters near Munich in Germany, is one of the world's top addresses for the design and construction of façades and complex building envelopes. Our deep understanding of the materials used has resulted in extraordinary solutions made of glass, steel, aluminium, membranes and other high-tech materials.

- founded in 1984
- more than 1,000 employees worldwide
- more than 100 realised retail stores all over the world



realising a brand's crown jewel

A retail store is the flagship of a brand. seele has extensive experience with shopping centers, retail stores, and brand architecture all over the world: whether it's an all-glass front with oversized glass panes for maximum transparency, or other architectural design options with various materials like bronze or mirror-polished stainless steel. Façades made by seele show the aesthetics, technology, and incomparable quality of a brand.

contents

- 2 company
- 4 realised stores
- 10 fabrication
- 12 time and reliability
- 16 engineering and materials
- 24 interior design



Puma Flagship Store, New York, USA



Fendi Store, Tokyo, Japan



Nike High Profile Store, New York, USA

realised stores

flagships around the globe



Burberry Flagship Store, New York, USA



Dyson Retail Store, New York, USA



Valentino Flagship Store, 5th Avenue, New York, USA



Balenciaga Store, Beverly Hills, USA



Dior Store, Rodeo Drive, Beverly Hills, USA

realised stores



Sternhöhe Möhringen, Stuttgart, Germany



KUBE Seadeck Kiosk at Victoria Dockside, Hong Kong



realised stores



Apple Retail Store Union Square, San Francisco, USA



Apple Retail Store Canton Road, Hong Kong



Apple Retail Store Piazza Liberty, Milan, Italy

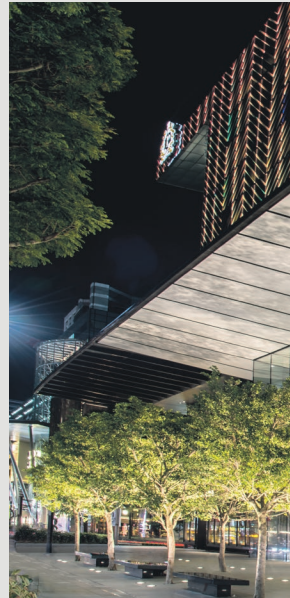



Apple Retail Store, Singapore



Apple Central World, Bangkok, Thailand



Apple Zorlu Center, Istanbul/Turkey

realised stores



fabrication

high-quality fabrication from a single source



1 Spacious and very well-equipped **production areas at our locations** provide space for large elements and high quantities.

2+3 Puma Flagship Store, New York: The ladders – consisting of welded and varnished elements – were up to 8m long and completed in one assembly line. In order to carry out the assembly on site as smoothly and in as straightforward a manner as possible, the entire façade construction relied on a high degree of prefabrication.



fabrication

Advanced manufacturing technologies for more efficiency and the highest precision in assembly are state-of-the-art at seele.

Production is closely coordinated with design and logistics to ensure an efficient workflow despite the many variants and large batches.

We offer a high level of expertise when it comes to architectural steel construction. The high expectations of quality run like a thread through all phases of our production. Tight tolerances and uncompromising accuracy reflect our exceptional expertise in façade construction.

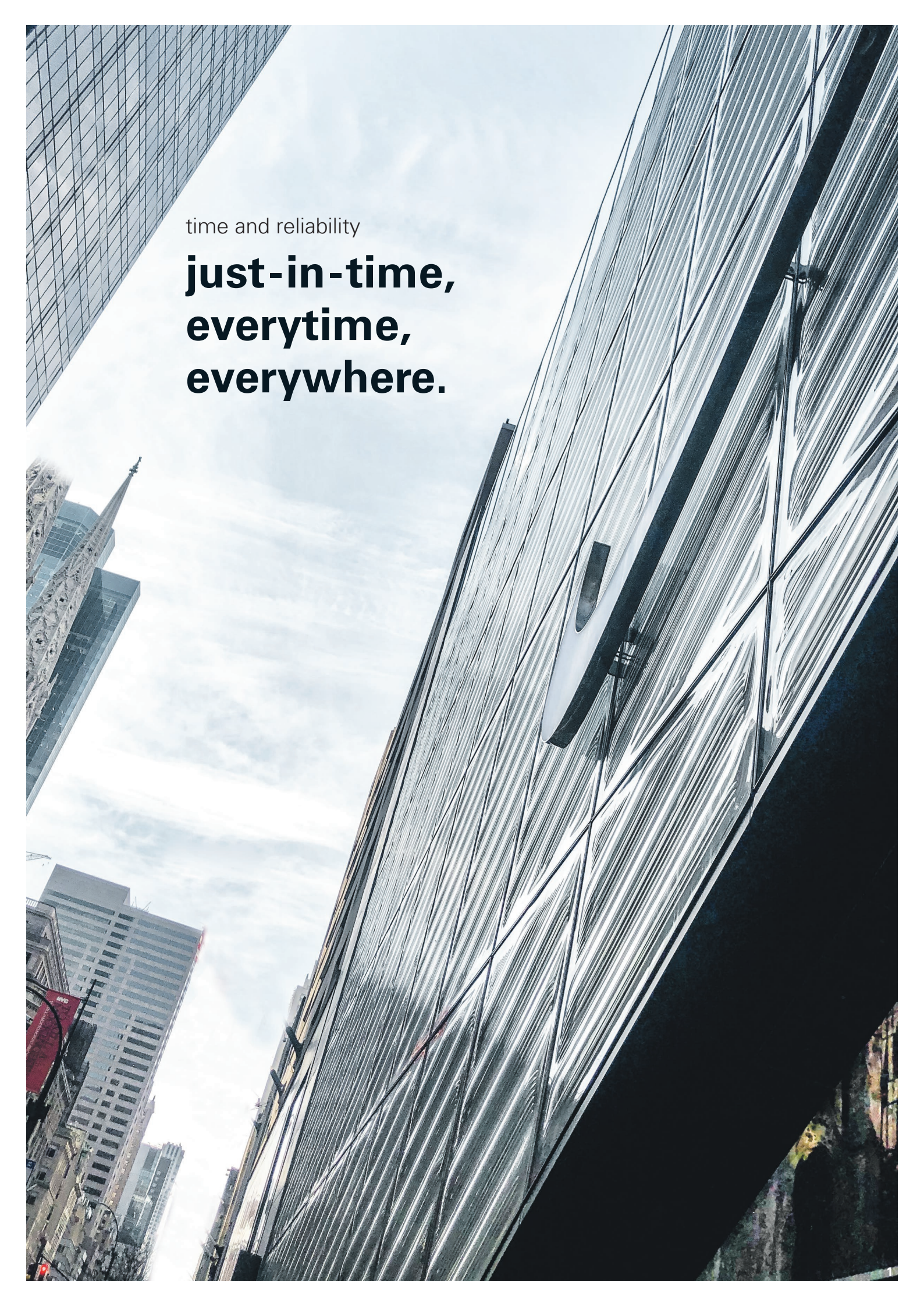

time and reliability

**just-in-time,
everytime,
everywhere.**



2+3 Safe transport: Every façade element had its own bespoke transport packaging, e.g. a wooden box, so that it could be safely transported.



time and reliability

Good logistics make projects more economical. And some projects would be unthinkable without careful logistics. seele is considered a specialist when it comes to transport, warehouse storage or on-site access, i.e. for large formats in the middle of a metropolis.

Just-in-time production and delivery of façade elements are the answer to construction projects on confined sites with limited storage options.

Local, geographical and climatic aspects are considered by our specialists when drawing up bespoke logistics concepts: from corrosion protection when shipping by sea to customs documents with verification of the total supply chain – everything is planned, down to the last detail.

1 Nike High Profile Store, New York: The quick installation of the glass façade met the ambitious and challenging time schedule: The mounting of the retail store had to be completed within only five months. The retail store's entrance façade is designed as an all-glass structure consisting of nine panes up to 5 m height and 2.70 m width.



detailed installation plans, safety concepts and temporary work stations ensure a perfect result, on schedule.

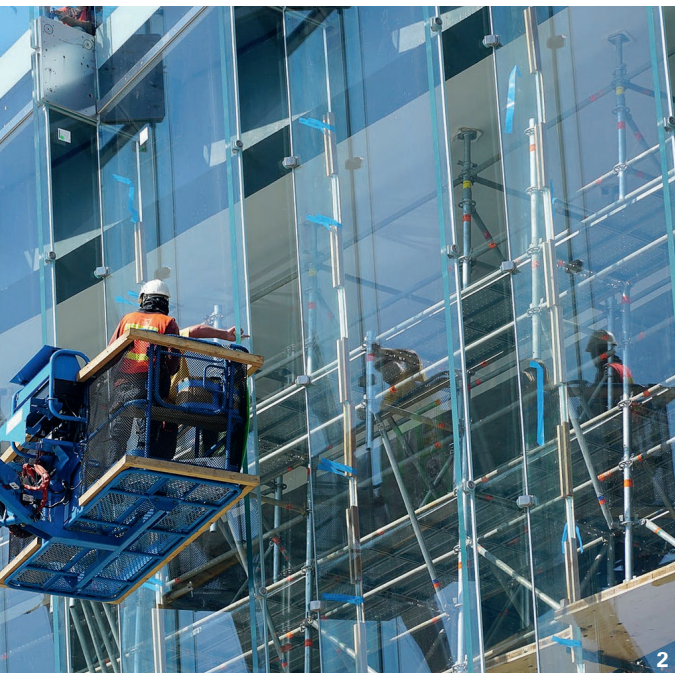

time and reliability

1 Apple Retail Store, San Francisco: The portal frames for the sliding doors were delivered to the rear of the building in four separate parts and then bolted together. After being raised into a vertical position with a crane, the frames were lifted over the building and installed.

2 ICONSIAM, Bangkok: For the assembly of the oversized glass fins and panes, two suction units with counterweight and three-axial adjustment were developed specifically for this project. Particularly spectacular was the installation of glass fins which were inserted in one piece, featuring 24m height and a weight of 5 t each.

3 Due to a tight schedule, the **Apple Cube in New York** had to be installed before the stair construction. The so-called drum was lowered downwards through an opening with only 75mm clearance on all sides.

engineering and materials

all-glass by seele: carrying the load in architecture



Minimal design, maximum transparency, large glass formats, amazing attention to detail – those are the attributes of the building envelopes that seele creates for world-famous architects.

You will look in vain for the fittings. It is the glass itself that carries heavy loads via shear-resistant interlayers. That opens up totally new possibilities for all-glass façades as well as glass balustrades and stairs in the interior.



1 + 2 ICONSIAM, Bangkok With a façade area of 5,300sqm across a length of approx. 300m, imposing glass fins and panes form a “colossal window” spanning 3 stories. To conform with the static requirements, the glass façade had to be suspended from the ceiling, wherein the glass panes are inclined in two directions and arranged in a zig-zag-shape. seele faced this challenge and developed an outstanding technical solution for the all-glass façade, which is 24m tall at its highest point.

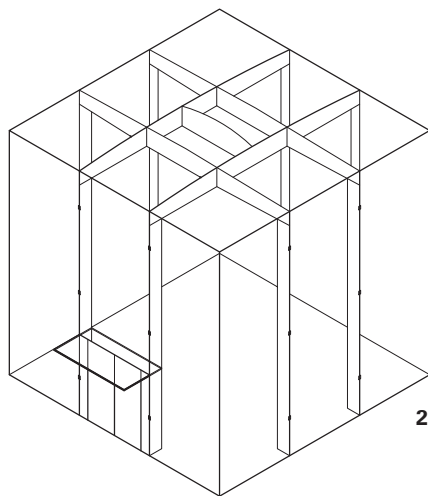

1 – 3 Apple Retail Store Cube 5th Avenue, New York: seele was appointed to (re-)design and (re-)build the iconic all-glass "Apple Cube" three times in a row (2006, 2011 and 2019).

Taking advantage of the latest developments and innovations in structural glass, the transparency of the design realised in 2011 is unprecedented and therefore was replicated in 2019. Each façade consists of only three panes of 5-ply laminated safety glass with the astonishing dimensions of 10.30 m × 3.30 m. The titanium fittings connecting the panes to the continuous glass fins have been laminated into the panes and are hardly visible.

4 Apple Retail Store Piazza Liberty, Milan: To achieve sophisticated architecture and maximum transparency in the entrance area, the all-glass cuboid has been structurally glazed without using any stainless steel fittings.



**one glass cuboid, four glass panes,
no mechanical connections**

**curved, grooved, alabaster laminated, golden –
the possibilities for processing glass are nearly endless**



Curved glass: Undulating glass façades are unique and timeless - ideal for exclusive and sophisticated retail façades to emphasise a brand.



Groove grinding: Rippled glass can be used as a privacy screen or as a pure design element. The grooves in the glass refract the light and create a charming play of light.

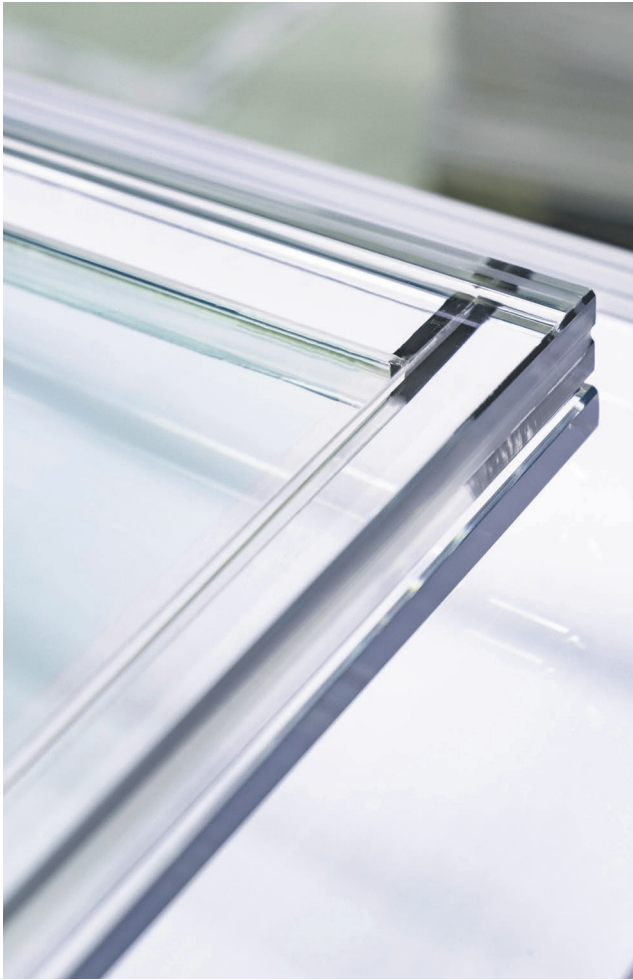

Invisible glass spacer: Insulating glass can be equipped with an invisible glass spacer to provide maximum transparency.

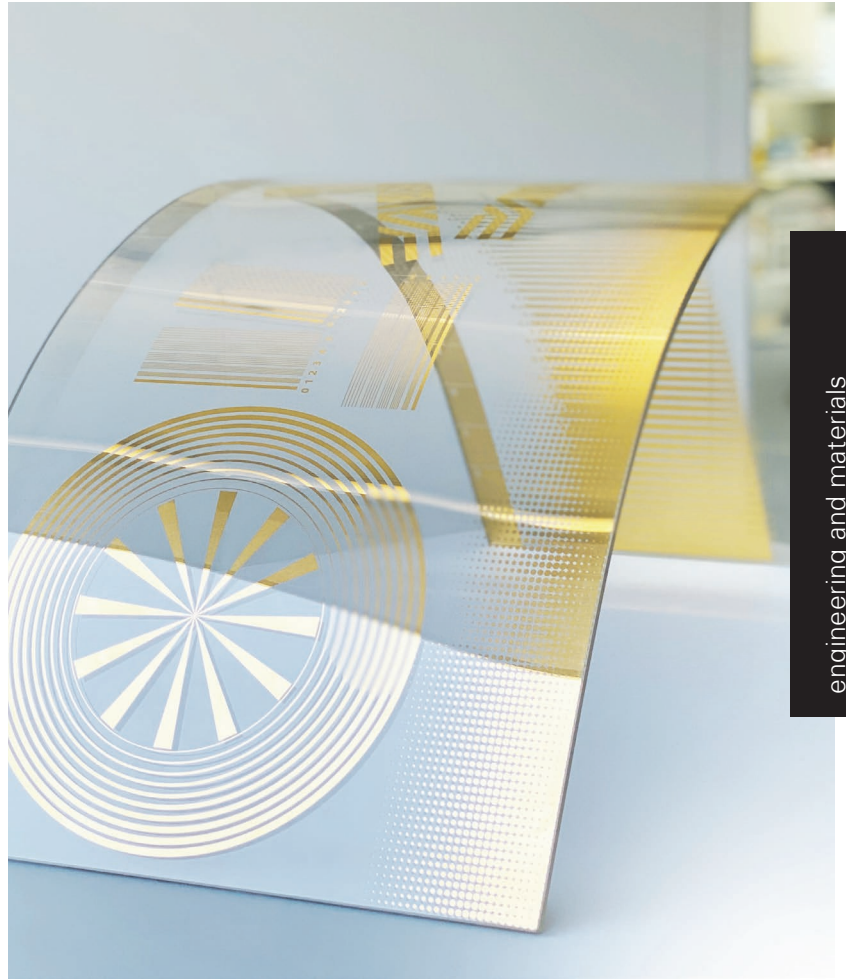

Printed gold: Digital printing technology brings precious metal on glass. Especially gold and silver result in a fascinating appearance and allow for even the finest details and filigree structures.



more than glass

With many years of experience in working with various materials such as glass, aluminium, stainless steel, bronze, brass and copper, we create singular building envelopes of excellent quality.

Whether milling precious metals, mirror-polished or polished stainless steel, or printed glass, we are accomplished in the surface treatment of metallic and non-metallic materials. Depending on the alloy, processing, and machining, the design options are very diverse.

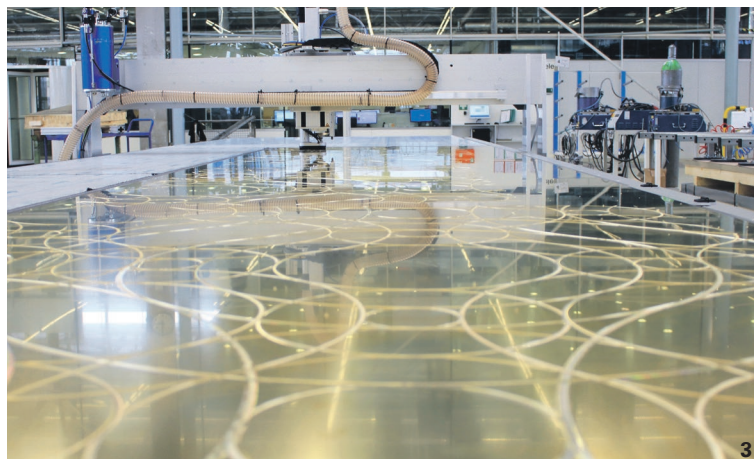
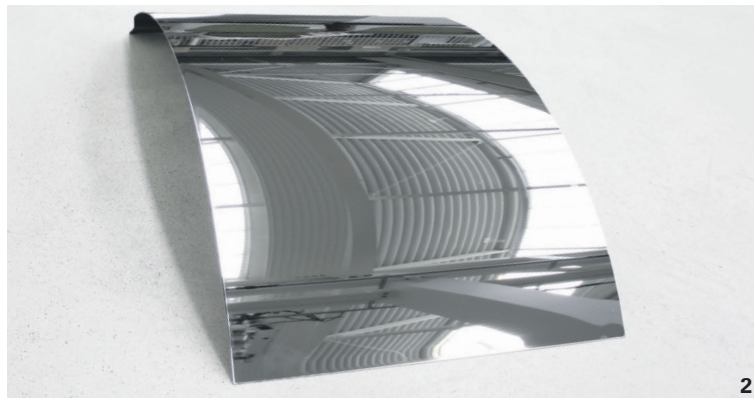

1 Copper and brass: Precious metals are enjoying a revival in recent years due to their use by a growing number of well-known architects. Copper and brass are used in many places and, due to their special properties, meet important functions.

2 Curved and polished sheet metal: With seele's comprehensive manufacturing expertise, high quality polished surfaces can be created – also with curved or 3D curved sheet metal.

3 Milling of brass sheets: The surface treatment of metallic and non-metallic materials is our speciality. For TEC Bridge, a bridge connecting two shopping malls in Toronto, Canada, every brass plate used is a one-off in terms of its geometry and the milling work required.

4 Patina: The rough character of Corten weathering steel lends the desired out-of-the-ordinary look. A transverse "wave" with an archaic look of the patina dominates the overall impression of the Fendi Store in Los Angeles.

interior design

unique designs, inside and outside



1 Glass stairs with minimalistic stainless steel fittings on the steps lead to the upper floor: the stairs seem to be floating in mid-air. Each step is fitted between a glass stringer and the wall clad in stainless steel.

All-glass constructions create light-flooded rooms, all-glass staircases give lightness to spaces, and balustrades are being built in new dimensions. Almost endless possibilities allow the creation of appealing designs.

By using a minimum of fittings, staircases and balustrades appear almost weightless. Thus, interiors with large format glass structures impress with a maximum of transparency.

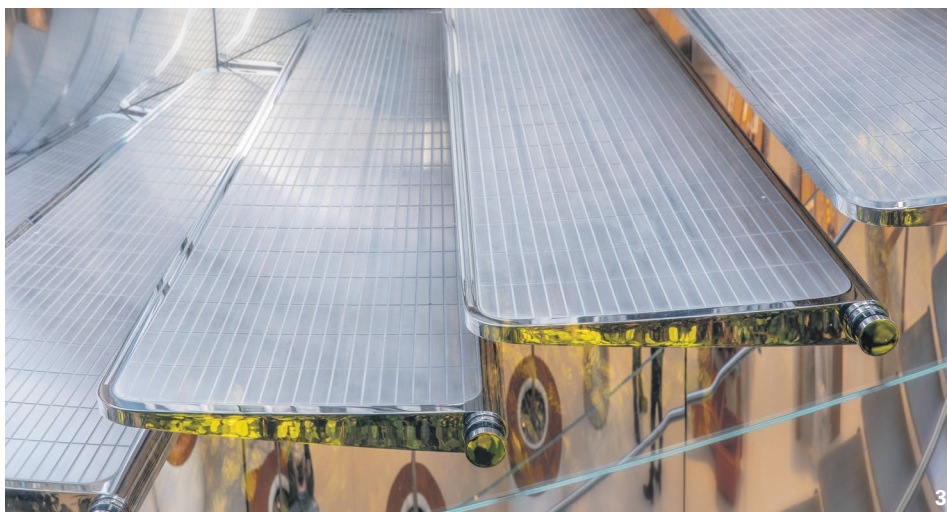

2 – 4 Glass doors, balustrades and elevators: All-glass interior design create a feeling of transparency and spaciousness.

seele

copyright

title © Adobe Stock **page 2/3** © Andreas Keller **page 4/5** © Nike, © seele **page 6/7** © seele, © Dior **page 8/9** © HG Esch, © Kevin Mak, courtesy of OMA **page 10/11** © Grisca Rueschendorf, © Brian Chong Chee Kang, © seele, © Giovanni Nardi Photography **page 12/13** © seele, © PUMA **page 14/15** © seele, © Vereinigte Nautische Sachverständige GmbH & CO. KG **page 16/17** © seele **page 18/19** © Andreas Keller **page 20/21** © Foster + Partners, © seele, © Giovanni Nardi Photography **page 22/23** © seele, © sedak **page 24/25** © seele, © Bernd Müller, © Mariko Reed **page 26/27** © Nigel Young/Foster + Partners, © Foster + Partners, © seele **back** © seele

Version 08/2021

seele.com